

Installation Manual

Blue Line Series

Air to Water Heat Pumps

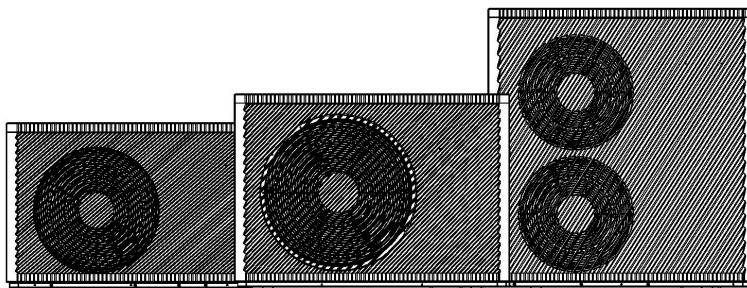

BL-8-1

BL-12-1, BL-12-3

BL-23-3

Content

1. Preface.....	3
2. Safety Instructions.....	4
3. Features.....	7
4. Unit Dimension(mm).....	8
5. Installation Diagram.....	9
6. Handling & Installation.....	10
7. Maintenance.....	17
8. Parameters.....	20
9. Wiring Diagram.....	22
10. Display Operation Guide.....	26
11. Failure List & Troubleshooting.....	37

1. Preface

In order to provide the customers with high quality, strong reliability and good versatility products, this heat pump is produced by strict design and manufacture standards. This manual includes all the necessary information about installation, debugging, discharging and maintenance. Please read this manual carefully before you open or maintain the unit.

The manufacture of this product will not be held responsible if someone is injured or the unit is damaged, as a result of improper installation, debugging, unnecessary maintenance which is not in line with this manual.

The unit must be installed by qualified personnel.

It is vital that the below instructions are adhered to at all times to keep the warranty.

—The unit can only be opened or repaired by a qualified installer or an authorized dealer.

—Maintenance and operation must be carried out according to the recommended time and frequency, as stated in this manual.

—Use genuine standard spare parts only.

Failure to comply with these recommendations will invalidate the warranty.



Inverter air source water heat pump is a kind of high efficiency, energy saving and environment friendly equipment, which is mainly used for house warming. It can work with any kinds of indoor unit such as fan coil, radiator, or floor heating pipe, by providing warm or hot water. One unit of monoblock heat pump can also work with several indoor units.

The air source water heat pump unit is designed to have heat recovery by using super heater which can provide hot water for sanitary purpose.



2. Safety Instructions

To prevent the users and maintainers from the harm of this unit, and avoid damage to the unit or other property, and use the heat pump properly, please read this manual carefully and understand the following information correctly.



Mark Notes



Mark	Meaning
 WARNING	A wrong operation may lead to death or grievous injury on people.
 ATTENTION	A wrong operation may lead to harm to people or loss of material.



Icon Notes



Icon	Meaning
	Prohibition. What is prohibited will be nearby this icon.
	Compulsory implement. The listed action needed to be taken.
	ATTENTION (include WARNING) Please pay attention to what is indicated.

Warning



Operation	Meaning
 Prohibition	DO NOT put fingers or others into the fan and evaporator of the unit, otherwise harm may occur.
 Shut off the power.	When there is something wrong or strange smells, the power supply needs to be shut off to stop the unit. Continue running may cause short circuit or fire.

Operation	Meaning
 Prohibition	DO NOT put fingers or others into the fan and evaporator of the unit, otherwise harm may occur.
 Shut off the power.	When there is something wrong or strange smells, the power supply needs to be shut off to stop the unit. Continue running may cause short circuit or fire.



Move and Repair	Meaning
 Entrust	When the heat pump needs to be moved or installed again, please entrust dealers or qualified people to carry it out. Improper installation will lead to water leakage, electrical shock, injury or fire.
 Entrust	It is prohibited from repair the unit by the user himself, otherwise electrical shock or fire may occur.
 Prohibit	When the heat pump needs to be repaired, please entrust dealers or qualified people to carry it out. Improper movement or repair on the unit will lead to water leakage, electrical shock, injury or fire.

	<p>Do not use means to accelerate the defrosting process or to clean, other than those recommended by the manufacturer.</p>
	<p>The appliance shall be stored in a room and installed in the environment without continuously operating or potential ignition sources (for example: open flames, an operating gas appliance or an operating electric heater or Electric Spark or hot objects).</p>

ATTENTION

Installation	Meaning
 Installation Place	<p>The unit CANNOT be installed near the flammable gas. Once there is any leakage of the gas, fire may occur.</p>
 Fix the unit.	<p>Make sure that the basement of the heat pump is strong enough, to avoid any decline or fall down of the unit</p>
 Need circuit breaker.	<p>Make sure that there is circuit breaker for the unit, lack of circuit breaker may lead to electrical shock or fire.</p>

Operation	Meaning
 Check the installation basement.	<p>Please check the installation basement regularly (once a month), to avoid any decline or damage to the basement, which may hurt people or damage the unit.</p>

 Switch off the power.	Please switch off the power when cleaning or maintaining.
 Prohibition	It is prohibited from using copper or iron as fuse. The right fuse must be fixed by electricians for the heat pump.
 Prohibition	It is prohibited from spray the flammable gas to the heat pump, as it may cause fire.

3. Features

This series of heat pump unit owns following features:

3.1. Advanced Controlling

The PC micro-computer based controller is available for the users to review or set the running parameters of the heat pump. Centralized controlling system can control several units by PC.

3.2. Nice Appearance

The heat pump is designed with beautiful looking. The monoblock one has the water pump included which is very easy for installation.

3.3. Flexible Installation

The unit has a smart structure with compact body, just as simple outdoor installation is needed.

3.4. Quiet Running

The heat pump unit use a special designed heat exchanger to enhance whole efficiency.

3.5. Good Heat Exchange Rate

The heat pump unit use a special designed heat exchanger to enhance whole efficiency.

3.6. Large Working Range

This series of heat pump is designed to work under different working conditions as low as -15 degrees for heating.

4. Unit Dimension(mm)

4.1. Models: BL-8-1

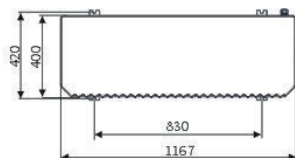
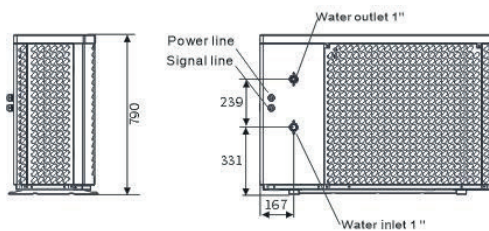
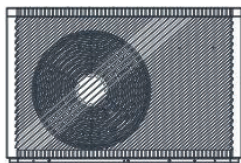

4.2. Models: BL-12-1, BL-12-3

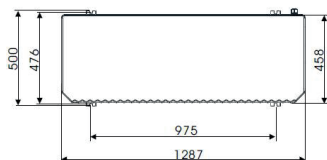
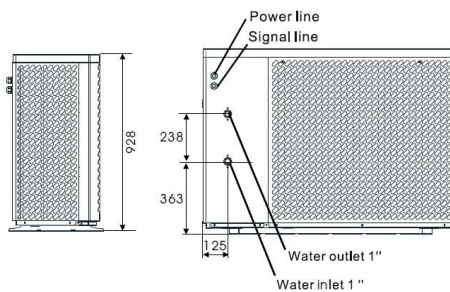
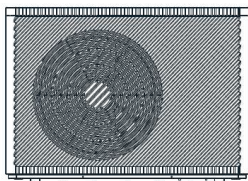

4.3. Models: BL-23-3

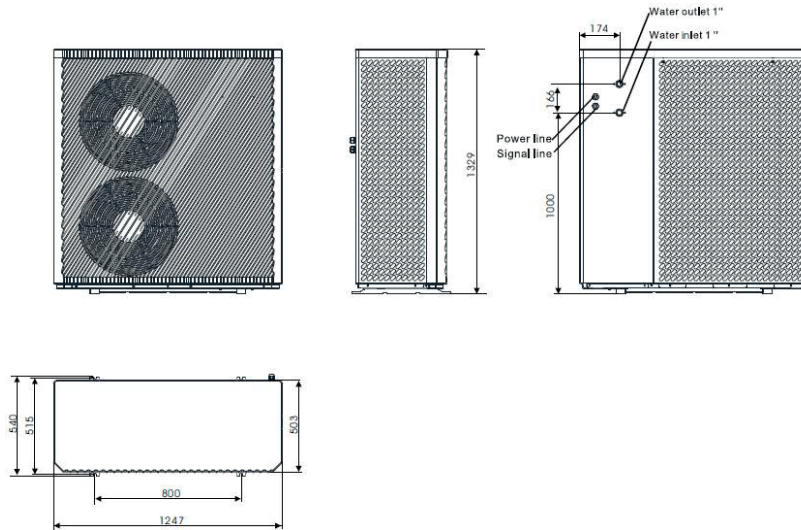

5. Installation Diagram

FoxAIR monoblock heatpumps can provide heating/cooling and domestic hot water. Floor heating loops and fan coil units are used for space heating and fan coil units are used for space cooling. Domestic hot water is supplied from the domestic hot water tank connected to the heat pump.

5.1 Traditional Installation

FoxAIR provides the monoblock heat pump with a main circulation pump built inside. When install the unit, installers should connect the heat pump with other parts including the buffer tank (for space heating/cooling), storage water tank (for domestic hot water) and water pumps (for space heating/cooling water circulation and domestic hot water). External fittings are also needed including a safety valve, a water charge valve, hot water valves (three-way valve). Temperature sensor should be added in the storage water tank. An additional electric heater can be installed in the DHW tank or the buffer tank which can get the control signal from the heat pump.

6.1. Application of Heat Pump

6.1.1. House Heating/Cooling + Domestic Hot Water

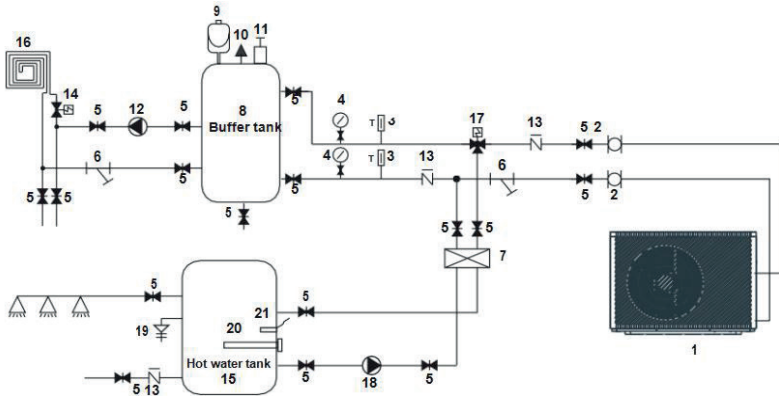

1	Heat pump	10	Relief valve	19	PT valve
2	Flexible pipe	11	Air vent valve	20	Electrical heater
3	Thermometer	12	Water pump for floor heating	21	Hot water sensor
4	Manometer	13	Check valve		
5	Shut-off valve	14	Floor heating valve		
6	Y type water filter	15	Hot water tank		
7	Plate heat exchanger	16	Floor heating pipe/fan coil unit		
8	Buffer tank	17	Hot water valve		
9	Expansion tank	18	Hot water pump		

Remark: Item 17, 18, 20, 21 can be connected with heat pump.

6.1.2. House Heating/Cooling (including Buffer tank)

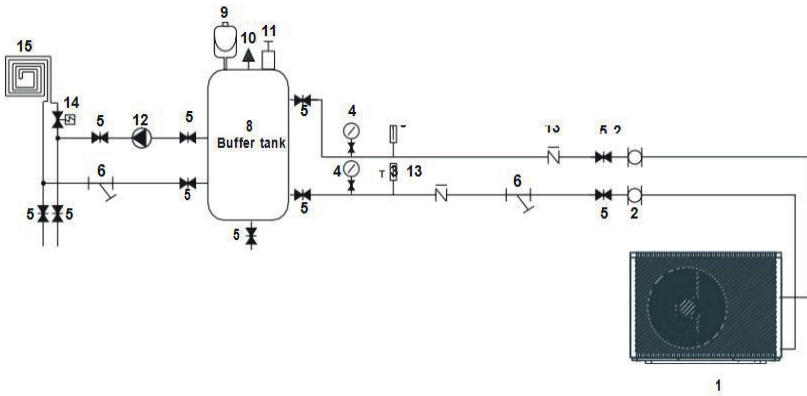

1	Heat pump	7	Plate heat exchanger	13	Check valve
2	Flexible pipe	8	Buffer tank	14	Floor heating valve
3	Thermometer	9	Expansion tank	15	Floor heating pipe/fan coil unit
4	Manometer	10	Relief valve		
5	Shut-off valve	11	Air vent valve		
6	Y type water filter	12	Water pump for floor heating		

6.2. Choose a right heat pump unit

- (1) Based on the local climate condition, construction features and insulation level, calculate the required cooling(heating) capacity per square meter.
- (2) Conclude the total capacity which will be needed by the construction.
- (3) According to the total capacity needed, choose the right model by consulting the heat.
- (4) Pump features as below:
 - a. Cooling only unit: chilled water outlet temp. at 5-15°C, maximum ambient temp. at 43°C.
 - b. Heating and Cooling unit: for cooling chilled water outlet temp. at 5-15°C, maximum ambient temp. at 43°C. For heating, warm water outlet temp. at 9-75°C, minimum ambient temp. at -25°C.
 - c. Unit application
Inverter air source water heat pump is used for house, office, hotel, and so forth, which need heating or cooling separately, with each area needed to be controlled.

6.3. Installation Method

The heat pump can be installed onto the concrete basement by expansion screws, or onto a steel frame with rubber feet which can be placed on the ground or housetop.

Make sure that the unit is placed horizontally.

6.4. Installation Place

- a. The unit can be installed on any place outdoor which can carry heavy machine such as terrace, housetop, ground and so on.
- b. The location must have good ventilation.
- c. The place is free from heat radiation and other fire flame.
- d. A pall is needed in winter to protect the heat pump from snow.
- e. There must be not obstacles near the air inlet and outlet of the heat pump.
A place which is free from strong air blowing.
- f. There must be water channel around the heat pump to drain the condensing water. There must be enough space around the unit for maintenance.
- g. A place which is far away operating or potential ignition sources (for example: open flames, an operating gas appliance or an operating electric heater or Electric Spark or hot object)

6.5. Refrigerant charge

The heat pump is not infused with the refrigerant **R32** and full of high-pressure nitrogen or keep it in a vacuum instead, please follow these steps to infusing refrigerant **R32**.

1. Preparations

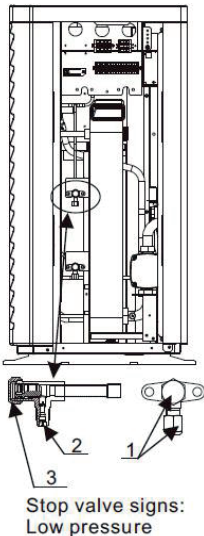

- a. Please in a well-ventilated environment while charge refrigerant.
 - b. Keep away from open flames or potential sources of fire.
 - c. Disconnect the power supply of the heat pump.
 - d. Carefully check the nameplate of the heat pump and charge strictly according to the labeled amount.
2. Check the pressure of nitrogen gas inside the system. The heat pump has charged about 30 Bar pressure nitrogen gas inside the system, please check whether there is still high-pressure nitrogen before charging refrigerant, otherwise check the leakage point. (Use spanner remove the seal nut 1 and 3, use 5mm inner hexagon spanner open the valve 2. If it can Blowing out the high-pressure gas then the heat pump is not leaking.)
3. Use 5mm inner hexagon spanner open the valve 2 and release all the nitrogen gas inside the system.

4. Vacuumize the heat pump. Connect the vacuum pump with the valve 2, keep vacuum pump running until the absolute pressure below 30Pa or operating time more than one hour.

5. Charge refrigerant. Keep the refrigerant in liquid state when charging and strictly according to the labeled amount.
6. Finish the charging, close the valve 2 and screw the seal nut 1 and 3.

6.6. Water Loop Connection

Please pay attention to below matters when the water pipe is connected:

- (1) Try to reduce the resistance to the water from the piping.
- (2) The piping must be clear and free from dirt and blocks. Water leakage test must be carried out to ensure there is no water leaking. And then the insulation can be made.
- (3) Attention that the pipe must be tested by pressure separately. DO NOT test it together with the heat pump.
- (4) There must be an expansion tank on the top point of the water loop, and the water level in the tank must be at least 0.5 meter higher than the top point of the water loop.
- (5) The flow switch is installed inside of the heat pump, check to ensure that the wiring and action of the switch is normal and controlled by the controller.
- (6) Try to avoid air staying inside of the water pipe, and there must be an air vent on the top point of the water loop.
- (7) There must be a thermometer and pressure meter at the water inlet and outlet, for easy inspection during running.

6.7. Power Supply Connection

- (1) Open the front panel, and open the power supply access.
- (2) The power supply must go through the wire access and be connected to the power supply terminals in the controlling box. Then connect the 3-signal wire plugs of the wire controller and main controller.
- (3) If the outside water pump is needed, please insert the power supply wire into the wire access also and connect to the water pump terminals.
- (4) If an additional auxiliary heater is needed to be controlled by the heat pump controller, the relay (or power) of the aux-heater must be connected to the relevant output of the controller.

6.8. Location of the Unit

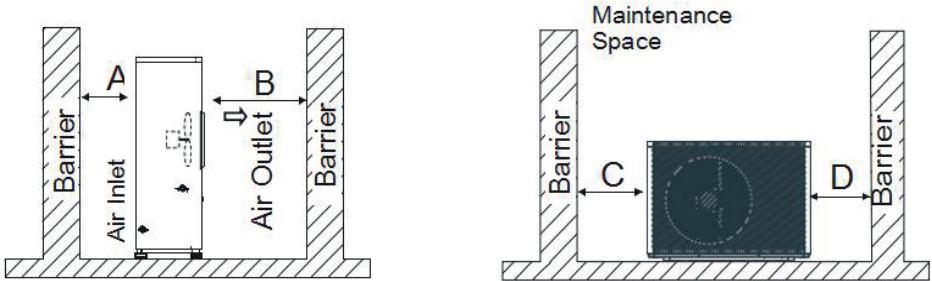

The picture shows the location of horizontal air outlet unit.



Attention

Requirements:

A>500mm ; B>1500mm ;

C>1000mm ; D>500mm

6.9. Transit

When the unit needs to be hung up during installation, an 8 meters cable is needed, and there must be soft material between the cable and the unit to prevent damage to the heat pump cabinet. (See picture 1)

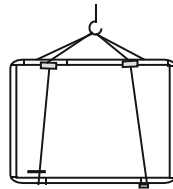

Picture 1



WARNING

DO NOT touch the heat exchanger of the heat pump with fingers or other objects !

6.10. Trial Running

6.10.1. Inspection before trial running

- (1) Check the indoor unit, and make sure that the pipe connection is right and the relevant valves are open.
- (2) Check the water loop, to ensure that the water inside of the expansion tank is enough, the water supply is good, the water loop is full of water

and without any air. Also make sure there is good insulation for the water pipe.

- (3) Check the electrical wiring. Make sure that the power voltage is normal, the screws are fastened, the wiring is made in line with the diagram, and the earthing is connected.
- (4) Check the heat pump unit including all of the screws and parts of the heat pump to see if they are in good order. When the power is on, review the indicator on the controller to see if there is any failure indication. The gas gauge can be connected to the check valves to see the high pressure (or low pressure) of the system during trial running.

6.10.2. Trial running

- (1) Start the heat pump by press "  " key on the controller. Check whether the water pump is running, if it runs normally there will be 0.2 MPa on the water pressure meter.
- (2) When the water pump runs for 1 minutes, the compressor will start. Hear whether there is strange sound from the compressor. If abnormal sound occurs please stop the unit and check the compressor. If the compressor runs well please look for the pressure meter of the refrigerant.
- (3) Then check whether the power input and running current is in line with the manual. If not please stop and check.
- (4) Adjust the valves on the water loop, to make sure that the hot(cool) water supply to each door is good and meet the requirement of heating (or cooling). Review whether the outlet water temperature is stable.
- (5) The parameters of the controller are set by the factory, it is not allowed to change then by the user himself.

If the water flow rate is lower than 70% of the rated water flow, the defrosting efficiency will be lower. The suggested water flow rate shall be the rated flow rate which is shown on the nameplate.

7. Maintenance

7.1. Precautions for Daily Use

Before starting up the unit for the first time or after a long-time shutdown, the following preparations must be made:

- (1) Thoroughly inspect and clean up the unit.
- (2) Clean the waterway system.
- (3) Check water pump, regulating valve and other waterway equipment.
- (4) Tighten all wire connections.

Do not change the system parameters before consulting the engineer.

Ensure the water refill and exhaust device in the waterway is well, otherwise the performance and reliability of the unit will become worse.

Ensure the waterways are clean and avoid dirt and blockage.

Timely check the electricity, water and replace the faulty parts.

Please use the parts provided or recommended by the company, do not use the unqualified parts.

Refrigerant supplement:

Each unit has been equipped with sufficient refrigerant when leaving the factory. Do not charge or change the refrigerant.

If you need to replenish the refrigerant due to leakage, please contact the engineers or dealers.

7.2. Periodic Maintenance (every 6 months)

Preparation	Before maintenance, please ensure that the unit stop running and cut off the power supply.
Inspection and cleaning of fin heat exchanger	In order to ensure that heat exchangers remain in optimum condition for heat exchange, their surfaces must be clean.
Inspection and cleaning of plate heat exchanger	Every 6 months or when the capacity of the unit drops by more than 10%, check the water-side heat exchanger for scale and clean the heat exchanger.
Check the electrical wiring	Check if the contact point is loose, oxidized, or blocked by sundries, etc., which causes poor contact of the electronic wiring.

7.3. Inspection and Maintenance

7.3.1. Preparing for inspection and maintenance

Danger!

Risk of death caused by fire or explosion if there is a refrigerant leakage!

Only carry out the work if you are competent and have knowledge about the special features and risks of **R32** refrigerant.

In case of leakage, R32 can form a flammable mixture with air in enclosed spaces, which may ignite in the presence of an ignition source.

Ensure that space is sufficiently aerated around the product.

Observe the basic safety rules before carrying out inspection and maintenance work or installing spare parts.

Disconnect the product from the power supply but ensure that the product is still earthed.

7.3.2. Cleaning the product

Do not clean the product with a high-pressure cleaner or a direct jet of water.

Clean the product using a sponge and hot water with a cleaning agent.

Do not use abrasive cleaners. Do not use solvents. Do not use any cleaning agents that contain chlorine or ammonia.

7.3.3. Checking the evaporator, fan, and condensate discharge

Check whether there is dirt between the fins or whether depositions have adhered to the fins.

Clean the fins using a soft brush, avoid fins from being bent.

Check whether dirt has been accumulated on the condensate tray or in the condensate discharge pipe.

Check whether the water can drain freely.

8. Parameters

Model		BL-8-1	BL-12-1	BL-12-3	BL-23-3
Power Supply	/	220~240V~/50Hz	220~240V~/50Hz	380~415V/3N~/50Hz	380~415V/3N~/50Hz
Moisture Resistance	IPX	IPX4	IPX4	IPX4	IPX4
Electrical Shockproof	I	I	I	I	I
Heating Condition - Ambient Temp. (DB/WB): 7/6°C, Water Temp. (In/Out): 30/35°C					
Heating Capacity Range	kW	2.3~8.20	3.80~12.50	3.80~12.50	7.0~23.0
Heating Power Input Range	kW	0.50~1.84	0.80~2.95	0.80~2.95	1.47~5.90
Heating Current Input Range	A	2.17~8.00	3.48~12.8	1.33~4.92	2.60~10.42
Cooling Condition - Ambient Temp. (DB/WB): 35/24°C, Water Temp. (In/Out): 12/7°C					
Cooling Capacity Range	kW	1.56~6.00	2.20~10.0	2.20~10.0	5.30~15.00
Cooling Power Input Range	kW	0.63~2.36	1.10~3.80	1.10~3.80	2.03~6.59
Heating Current Input Range	A	2.74~10.3	4.78~8.26	1.84~6.36	3.59~11.64
Hot Water Condition - Ambient Temp. (DB/WB): 20/15°C, Water Temp. (In/Out): 15/55°C					
Hot Water Capacity Range	kW	3.00~9.50	4.15~16.00	4.15~16.00	8.80~26.20
Hot Water Power Input Range	kW	0.62~2.30	0.90~3.85	0.90~3.85	2.10~6.29
Hot Water Current Input Range	A	2.70~10.0	3.91~17.2	1.50~6.43	3.71~11.11
Max. Power Input	kW	2.9	4.95	4.95	8.3
Max. Current Input	A	13	21.4	8	15
Water Flow	m³/h	1.0	1.7	1.7	2.9
Refrigerant / Proper Input	kg	R32 / 1.1 kg	R32 / 1.8 kg	R32 / 1.8 kg	R32 / 2.0 kg
CO ₂ Equivalent	Ton	0.74	1.22	1.22	1.35
Sound Pressure (1m)	dB(A)	41	43	43	45
Sound Power Level (EN12102)	dB	55	58	60	61
Net Weight	kg	90	132	132	208
Operation Pressure(Low Side)	MPa	2.1	2.1	2.1	2.1
Operation Pressure(High Side)	MPa	4.4	4.4	4.4	4.4
Unit Dimension(L/W/H)	mm	1167×407×795	1287×458×928	1287×458×928	1250×540×1330
Shipping Dimension(L/W/H)	mm	1300×485×940	1420×540×1080	1420×540×1080	1380×570×1480

Compressor	Brand	Panasonic	Panasonic	Panasonic	Panasonic	Panasonic
Circulation Pump	Brand	SHIMGE	SHIMGE	SHIMGE	SHIMGE	SHIMGE
Operating Ambient Temperature	°C	-25~43	-25~43	-25~43	-25~43	-25~43
Fan Quantity	/	1	1	1	1	2
Fan Motor Type	/	DC motor	DC motor	DC motor	DC motor	DC motor
Fan Motor Power Input (min~max)	W	55~105	60~120	60~120	60~120	30~80
Fan Speed (RPM)	RPM	300~600	300~600	300~600	300~600	300~750
Water Connection (inch)	inch	1	1	1	1	1
Water Pressure Drop (max)	kPa	40	45	45	45	69
Circulation Pump Head	m	7.5	7.5	7.5	7.5	12.5
Cabinet Type		Galvanized sheet+ ASA	Galvanized sheet+ ASA	Galvanized sheet+ ASA	Galvanized sheet+ ASA	Galvanized sheet+ ASA

9. Wiring Diagram

9.1. Model: BL-8-1

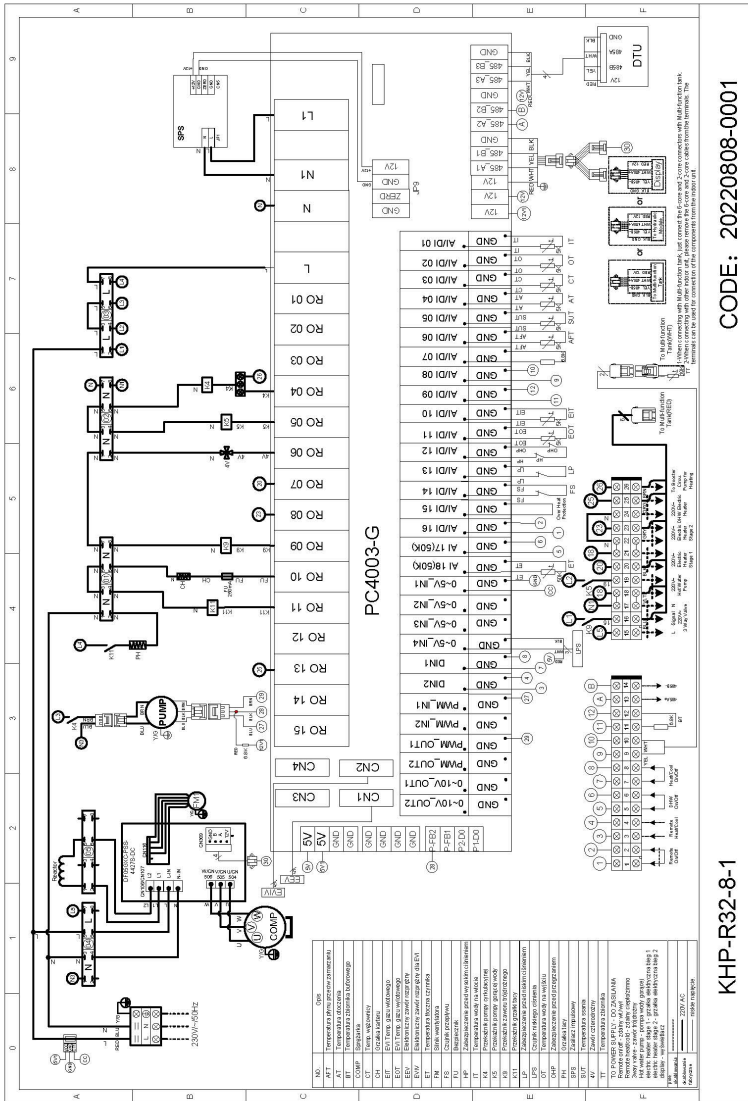

CODE: 20220808-0001

KHP-R32-8-1

9.3. Model: BL-12-3

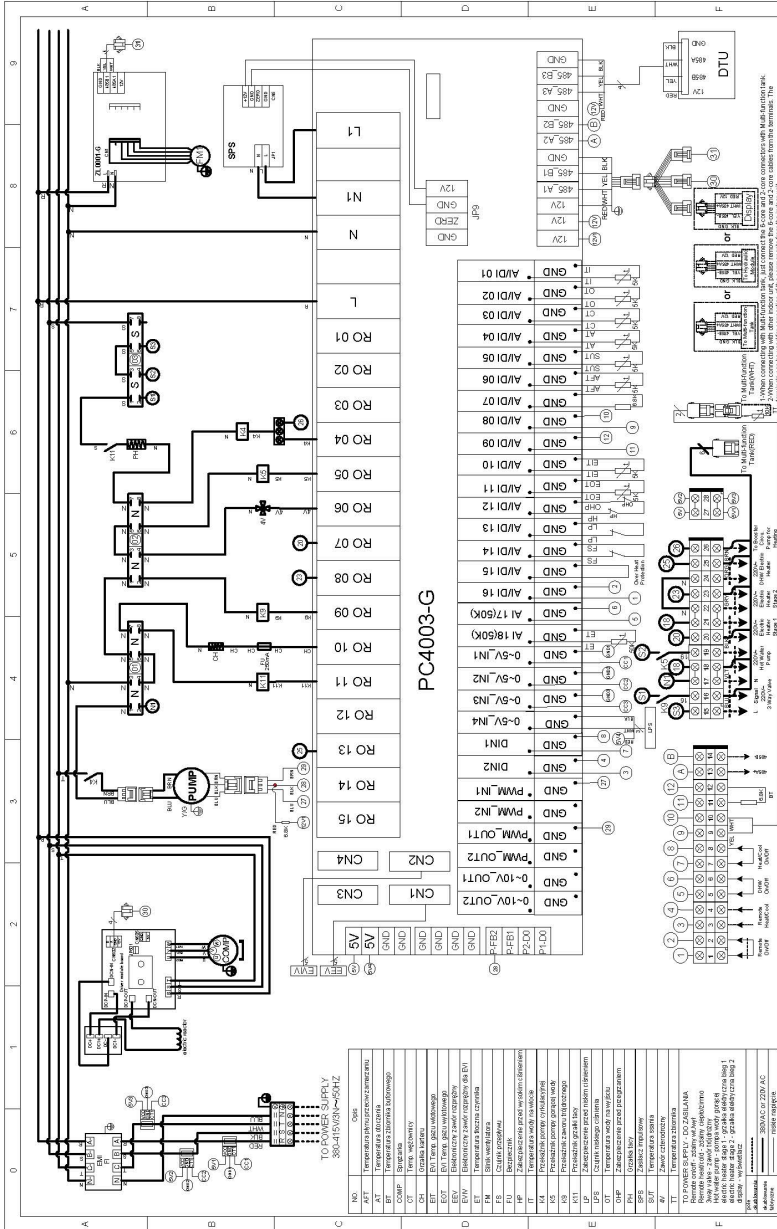

CODE: 20220808-0002

KHP-R32-12-3

9.4. Model: BL-23-3

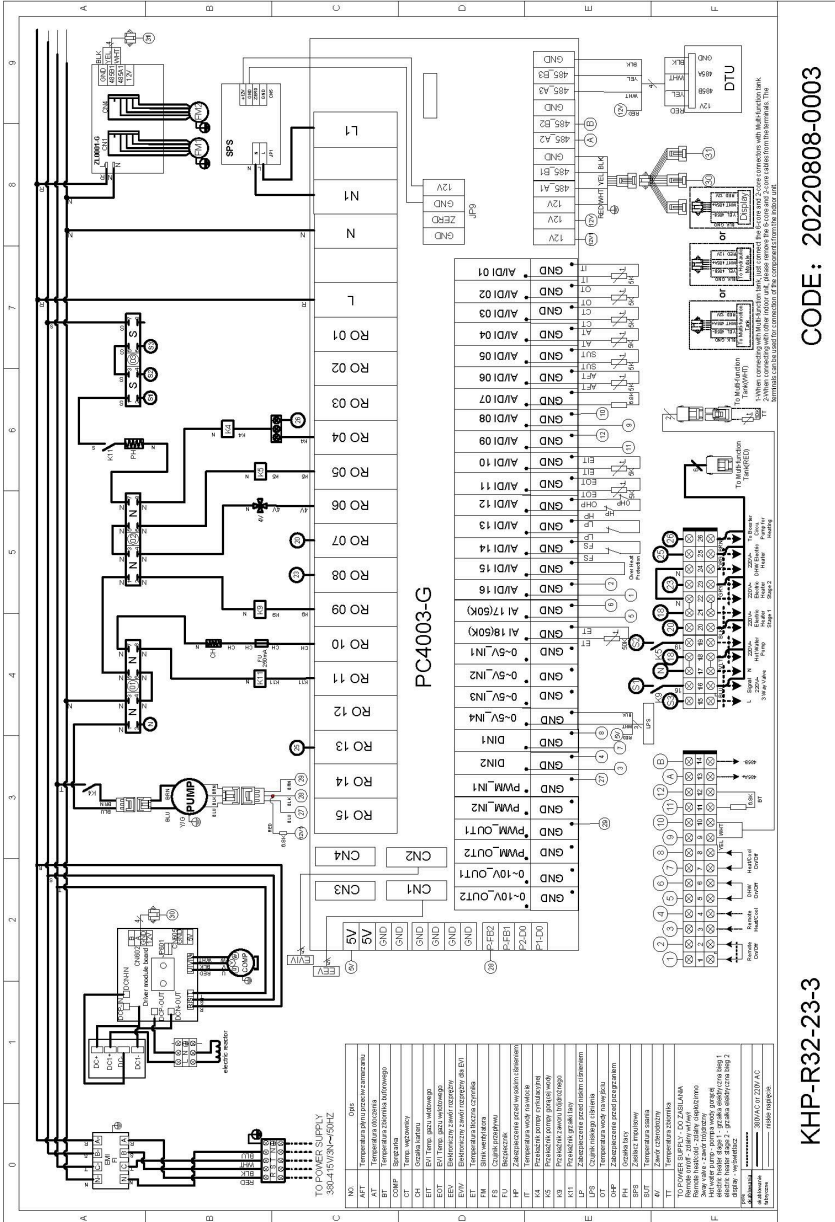

CODE: 20220808-0003

KHP-R32-23-3

10. Display Operation Guide

10.1. Main Interface Display and Function

(1) Power on Interface

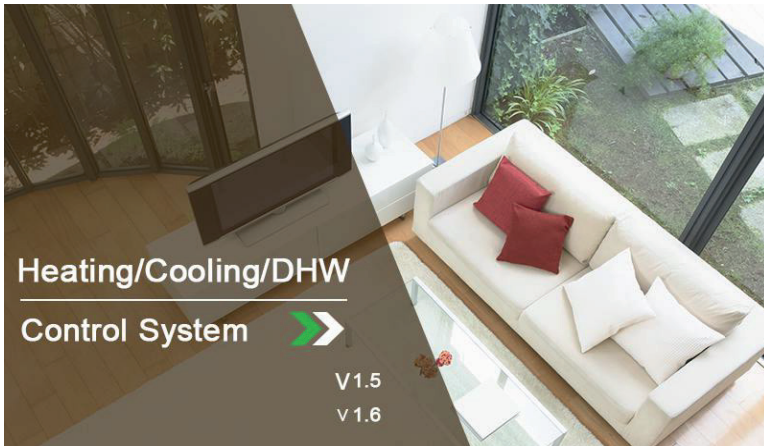

(2) Starting up Interface

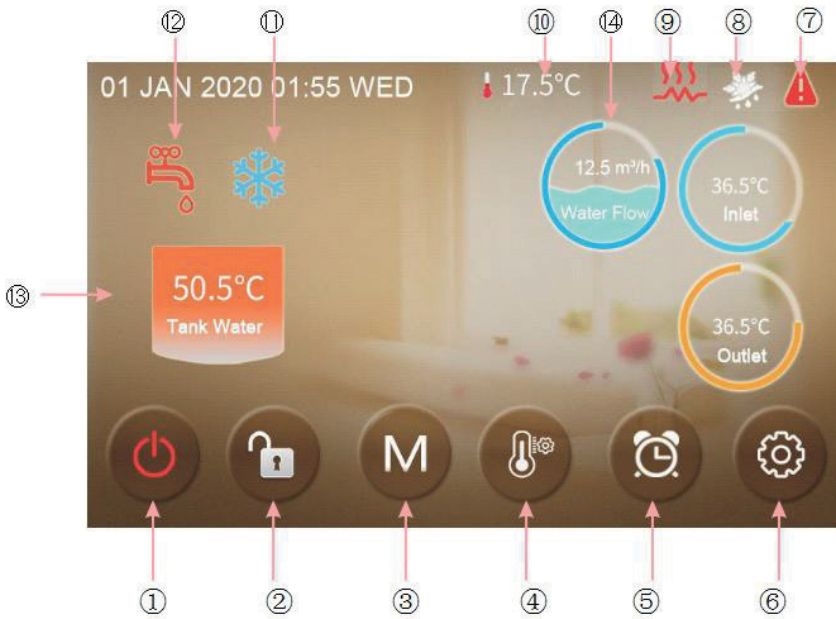

Key No.	Key Name	Key Function
①	ON/OFF	Switch the unit ON or OFF. Red represents ON, while grey represents OFF.
②	Lock Screen	Lock the screen. White represents disabled, while green represents enabled.
③	Running Mode	Switch Hot water mode, heating mode, cooling mode, hot water + heating mode or hot water + cooling mode
④	Temperature Setting	Set the target temperature.
⑤	Timer Setting	Set the timer. White represents disabled, while green represents enabled.
⑥	Setup	Check the unit status, time, factory parameter, temperature curve, timer setting and mute setting.
⑦	Fault	This icon will flash when there is an error showing up. The display will enter fault record interface after tapping this icon.
⑧	Defrosting	The unit is in defrosting mode when this icon shows up.
⑨	Electric Heater	The unit is in electric heater mode when this icon shows up.
⑩	Ambient Temperature	It shows the current ambient temperature.
⑪	Cooling Mode	The unit is in cooling mode when this icon shows up.
⑫	Hot Water Mode	The unit is in hot water mode when this icon shows up.
⑬	Tank Water Temperature	The unit is in hot water mode when this icon shows up; Otherwise, this icon is not shown.
⑭	Water Flow (Not available for model P24T)	It shows the current water flow (note: When H31=0, the icon is not displayed).
⑮	Room Temperature	It shows the current room temperature.

10.2. ON/OFF

As the main interface shows

(1) In the shutting down interface (on/off key is in grey status), press the on/off key can start up the machine.



(2) Note: In starting up interface (on/off key is in red status), press the on/off key can shut down the machine.

10.3. Mode Switch



In the main interface, there are five modes that can be selected after tapping the mode key.

(1)tapping hot water mode icon ①, then the display will change to this mode's interface;

(2)tapping heating mode icon ②, then the display will enter this mode's interface;

(3)tapping cooling mode icon ③,then the display will switch to this mode's interface;

(4)tapping hot water + heating mode icon ④, then the display will go into the hot water + heating mode's interface;

(5)tapping hot water + cooling mode icon ⑤, then the display will come to the hot water + cooling mode's interface;

Note: If your unit is a heating-only model (without a cooling function), the "cooling" key will show on the interface.

10.4. Set Target Temperature

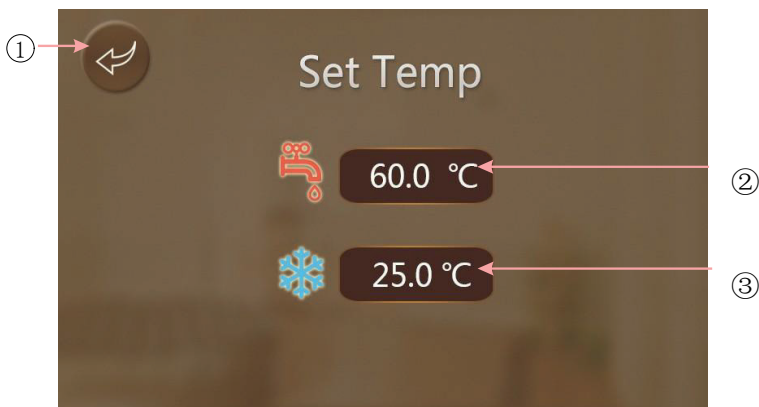

Take hot water + cooling mode for example:

Tapping①, the wire controller will back to the main interface;

Tapping②, the target temp of hot water can be set by the pop-up keyboard;

Tapping③, the target temp of cooling mode can be set by the pop-up keyboard.

When the target temp is being set, the pop-up keyboard is shown as following:

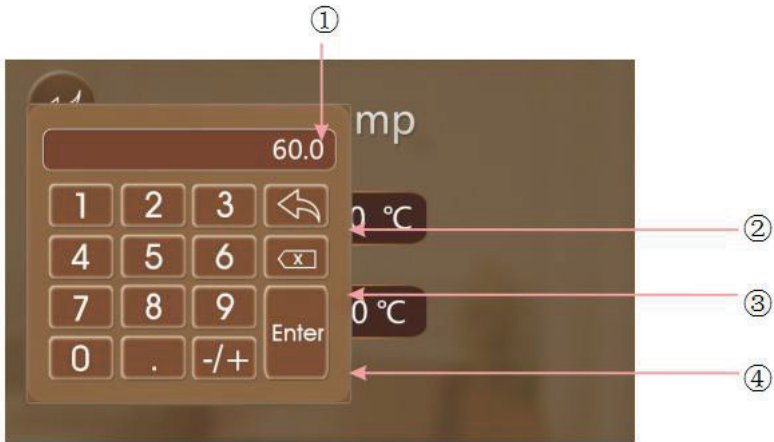

Key No.	Key Name	Key Function
②	Return key	Tapping this key can back to the main interface.
③	Delete key	Tapping this key to undo the last action.
④	Enter key	Tapping this key can save you action and back to the main interface.

Note: ① means the new target temp under current setting

10.5. Unlock Screen

Click the lock screen key again while the screen has been locked, the pop-up keyboard is shown as following:

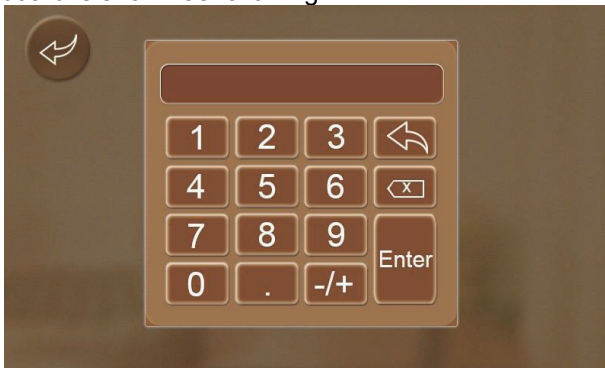

Note: Input the password of 22 or 022 and click the enter key, the screen will be unlocked.

10.6. Timer Setting

Click the timer setting key to enter the timer setting, the interface display is as follows:



Key No.	Key Name	Key color	Key Function
①	Return key		Click this key to return to the main interface.
②	Enable the timer on	Enable: Green ON Disable: Gray OFF	Click this key to start or turn off the timed start-up function
③	Enable the timer off	Enable: Red ON Disable: Gray OFF	Click this key to start or turn off the timed shutdown function
④	Hour of timer on		Hour of Timer on is shown
⑤	Minute of timer on		Minute of Timer on is shown
⑥	Hour of timer off		Hour of Timer off is shown
⑦	Minute of timer off		Hour of Timer off is shown

Such as the above figure: Under the state of unmanned operation, it will start the timed start-up at 17:10 and will be timed shutdown when running to 20:10.

10.7. Setup

Click the setup key to enter the setup and the interface display is shown as follows:

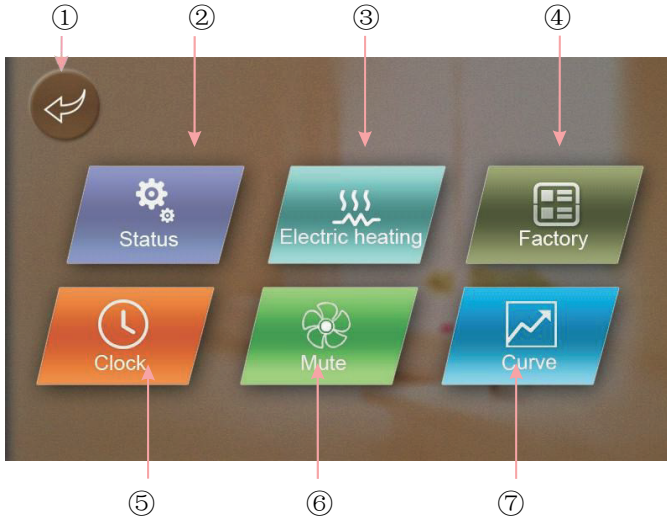

Key No.	Key Name	Key Function
①	Return key	Click this key to return to the main interface.
②	Operating mode	Click this key to view the current operating parameters of the unit.
③	Electric heating	Click this key to turn on the unit Electric heating.
④	Factory parameter	Click the key and enter the password to enter the factory parameter settings and status parameters interface.
⑤	System time setting	Click this key to set the system time.
⑥	Mute setting	Click this key to set the unit mute function mode.
⑦	Curve key	Click this key to view the temperature curve.

Note: If the unit has ②, ⑥ or both functions, the corresponding icon will be displayed on the setting interface.

In the setup interface:

(1) Tapping operating mode button②, then the interface display is shown as follows:

(2) Tapping system time setting button⑤, then the interface display is shown as follows:



Key No.	Key Name	Key Function
①	Return key	Click this key to return to the setup interface.
②	Up key	Click this key to increase the value.
③	Down key	Click this key to decrease the value.
④	Cannel key	Click this key to cancel the current settings and return to the settings page.
⑤	Enter key	Click this key to save the current settings.

Note:

- ①: Click the up and down key to set the month;
- ②: Click the up and down key to set the day;
- ③: Click the up and down key to set the year;
- ④: Click the up and down key to set the hour;
- ⑤: Click the up and down key to set the minute;
- ⑥: Click the key to cancel the setting;
- ⑦: Click the key to determine the setting, and the system will be automatically calibrated if it is incorrect.

(3) Tapping Electric heating button③, then the interface display is shown as follows:

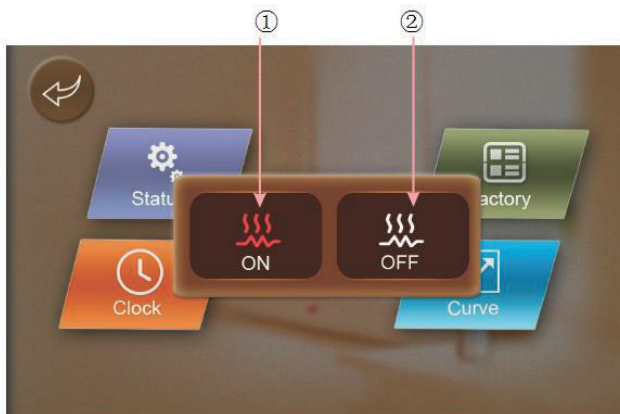

Note:

When the unit starts the electric heating , the icon is displayed as ①;



When the unit closes the electric heating , the icon is displayed as ②;

While the unit is in cooling mode , clicking the icon ①, the electric heating will not be turned on;

While the unit is in hot water+cooling mode , if the hot water side is running, the electric heating will be operated and shown; if the cooling side is running,clicking the icon ①, the electric heating will not be turned on.

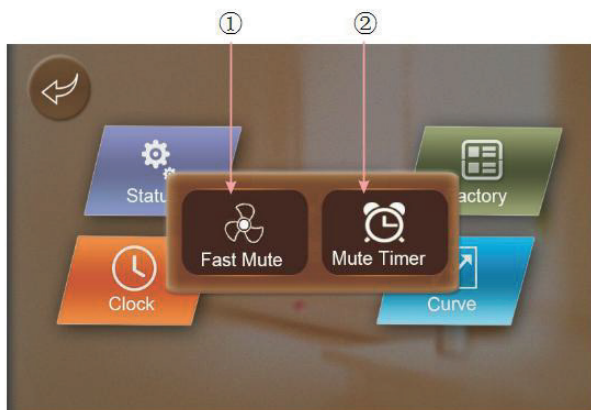
(4) Tapping Mute setting button⑥, then the interface display is shown as follows:



Note: When the unit is enabled to activate the mute function, the icon ① is displayed as ; When the unit is enabled to activate the powerful function, the icon ① is displayed as .

(5) Tapping Mute Timer button ②, then the interface display is shown as follows:

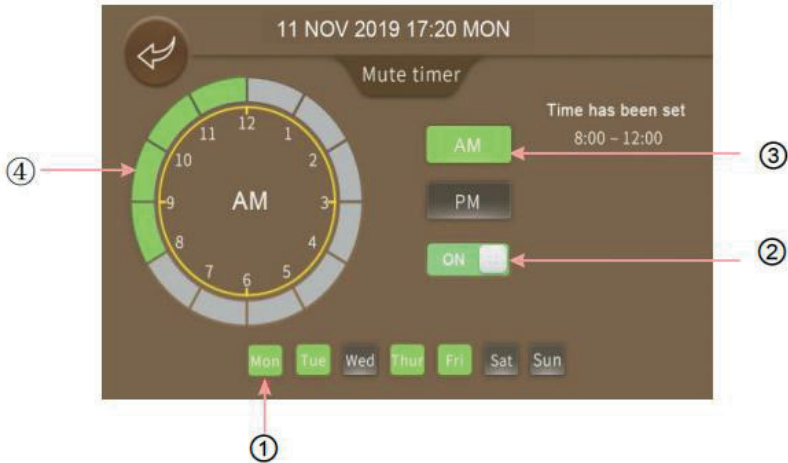

Note: Click ① to set the day of the week, click ② to activate the mute mode, then click ③ to select the morning or afternoon mode, and finally click ④ to select the time period to turn on the silent mode.

(6) Tapping Curve button ⑦, then the interface display is shown as follows:

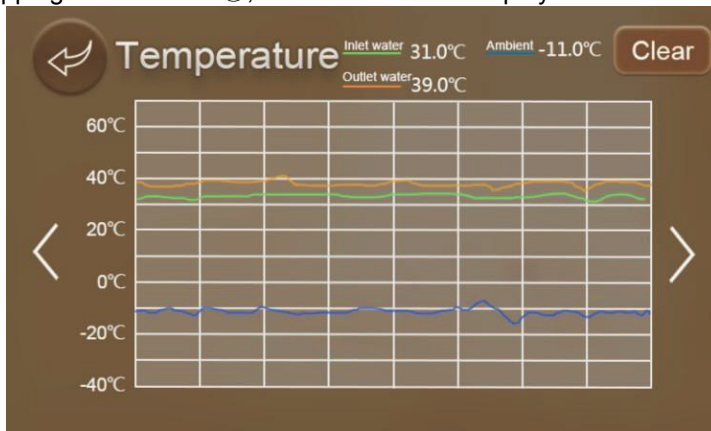

- a. This curve function records the water inlet temperature and water outlet temperature;
- b. Temperature data is collected every five minutes and the 12 sets of temperature data are saved every hour. Timekeeping is made from the latest data saving, if the power is disrupted when the time is less than 1 hour (12 sets), the data during such period will not be saved.

- c. Only curve for power-on status is recorded, and that for power-off will not be saved;
- d. The value of the abscissa indicates the time from the point on the curve to the current time point. The leftmost point on the first page (0 on the abscissa) is the latest temperature record;
- e. Temperature curve record is provided with power-down memory function.

10.8. Locking Window Function

(1) When the main window has been locked, it will show as below:

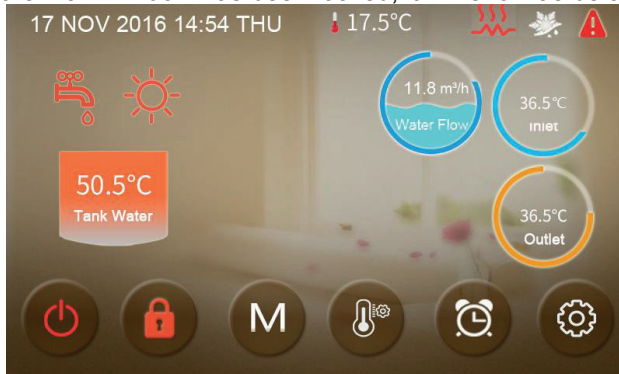

(2) Unlock the mainboard window

Click the “lock” key to unlock the window, it needs to input the password 22 or 022;

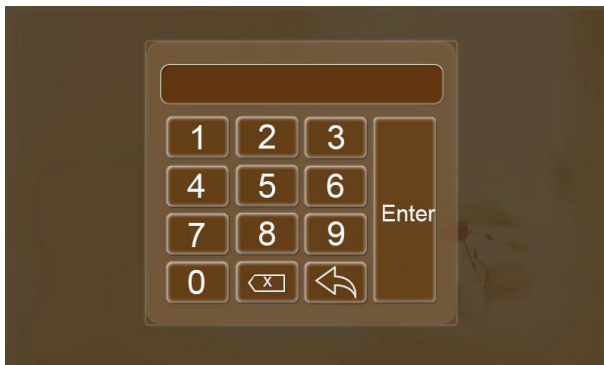

11. Failure List & Troubleshooting

11.1. Failure Handling

Issue	Possible cause	Related components	Solution
Unit tripped when powered on	Short circuit	Terminals Relays Contactors cables	Check all the components' connection Check relays and contactors whether are broken Disconnect the electronic components one by one and powered on to find the problem
Display cannot get power	Cables has disconnected The power input cable is mis-connected	Display cable Power input cable	Check the display cable Check the power cable Check the 3-phase power cable whether connected in right phase sequence
cannot start up the unit	The unit have error Cables has disconnected	Display Cables	Check the display whether shown error Reconnect the cable
Display cannot work	The display has been locked The display is broken	Display	Check the display whether shown locked icon Check the cable Reconnect the power cable and check if it works
Heating effect is not good	The compressor running low frequency The fan is not running or speed is too low Leakage problem	Compressor Fan Refrigerant system	Check the compressor frequency Check the fan speed Check the exhaust temperature and low pressure
Shut off while didn't reach the target temperature	Temperature limit (according to ambient temperature)	Control logic	Check the parameters
The evaporator has too much frost and cannot defrosting cleanly	Fan blade or motor issue EEV step is not suitable Refrigerant amount issue Parameter issue	Parameters Fan EEV Refrigerant system	Check the defrosting parameters Check the compressor frequency Check the fan speed Check the exhaust temperature and low pressure
Abnormal noise	Screws issue Fan blade or motor issue Compressor issue Components have collision	Screws Fan Compressor Other components (tubes, cables)	Check the screws Check the fan blade and motor Check the compressor Check other components

11.2. Error Code Instruction

Error code	Error name	Relevant parts information	Review and resolve
E04	Electric heater over heat Protection		<ol style="list-style-type: none"> 1. Check the Electrical heating Overheat protector open or not. 2. Check the Electrical heater.
E08	Communication failure between PCB and display	Communication error between PCB and DISPLAY	<ol style="list-style-type: none"> 1. Check cable connection of PCB and DISPLAY. 2. Check the software version of PCB and DISPLAY.
E11	HP Protection	HP switch is open	<ol style="list-style-type: none"> 1. Check whether showing the error after unit shutdown. 2. Measure the discharge pressure when unit is running. 3. Detect EEV step, suction pressure, inlet/outlet water discharge and suction temp. 4. Release all the gas of the system and refill refrigerant according to the nameplate.
E12	LP Protection	LP switch is open	<ol style="list-style-type: none"> 1. Check whether showing the error after unit shutdown. 2. Measure the suction pressure when unit is running. 3. Detect EEV step, discharge pressure, inlet/outlet water discharge and suction temp. 4. Release all the gas of the system and refill refrigerant according to the nameplate.
E19	Primary Anti-freezing Protection	Ambient temp. \leq 0 $^{\circ}$ C, A04-2 $^{\circ}$ C \leq water inletsA04 $^{\circ}$ C	It is the protection in winter. Once the water temperature rises up to A04+4 $^{\circ}$ C or the ambient temp is higher than 1, the error code disappears.
E29	Secondary Anti-freezing Protection	Ambient temp. \leq 0 $^{\circ}$ C, water inletsA04-2 $^{\circ}$ C	It is the protection in winter. Once the water temperature up to A04+11 $^{\circ}$ C or the ambient temp is higher than 1, the error code disappears.
E19	Primary Anti-freezing Protection	Ambient temp. \leq 0 $^{\circ}$ C, 2 $^{\circ}$ C \leq water inlets4 $^{\circ}$ C	It is the protection in winter. Once the water temperature rises up to 8 $^{\circ}$ C or the ambient temp is higher than 1 $^{\circ}$ C, the error code disappears.
E29	Secondary Anti-freezing Protection	Ambient temp. \leq 0 $^{\circ}$ C, water inlets2 $^{\circ}$ C	It is the protection in winter. Once the water temperature up to 15 $^{\circ}$ C or the ambient temp is higher than 1 $^{\circ}$ C, the error code disappears.
E032	Flow Switch Protection	Flow switch is open	<ol style="list-style-type: none"> 1. Detect the connection of cables. 2. Detect the flow switch. 3. Detect the water valve is opened or opened fully. 4. Detect the water pump, and the filler. 5. Maybe there is some air in the water route.
E051	Compressor Over current Shutdown Fault	Compressor Over current	<ol style="list-style-type: none"> 1. Check ambient temp. and inlet/outlet water temp.; 2. Turn on the unit. Record and analyze the changing process of high/low pressure, discharge/suction temp., EEV step, compressor frequency and running current. 3. If they are OK, replace a new compressor driver board.
E065	High water outlet temp. protection		Check if the water flow is too low and the outlet water whether too high
E081	Communication failure between PCB and fan drive board	Communication error between PCB and fan drive board	<ol style="list-style-type: none"> 1. Check the connection between PCB and fan board. All of 12V-12V, GND-GND, A-A, B-B should be closed; 2. If they are closed, turn on the power, then measure the voltage between 12V and GND on fan board, if higher than 15V or lower than 7V, replace a new fan board.

E103	Fan motor overload protection		<ol style="list-style-type: none"> 1. Check if the fan motor running well. 2. Detect the current of fan motor. 3. If the current is more than 1A, it means the motor have problem and need to replace a new one. 4. If the current is less than 1A, it means the motor control module have problem and need to replace a new one.
E171	Anti-freezing Protection	inlet water \leq A04℃ and the antifreeze temp <input checked="" type="checkbox"/> A04-A05 <input checked="" type="checkbox"/>	<ol style="list-style-type: none"> 1. Check the water flow. 2. Check the outlet water temp sensor. 3. Measure the ambient temp. 4. Detect the connection of cables. 5. Check the record of defrosting, whether the defrosting time is too long or too often. <p>Restart the unit.</p> <ol style="list-style-type: none"> 1. Check the changing process of EEV step, high pressure, low pressure, inlet/outlet water temp. 2. Check the connection of U/V/W between compressor and compressor driver board. 3. Check the compressor resistance. 4. Check compressor driver board.
F01	Compressor activation failure		<p>Restart the unit.</p> <ol style="list-style-type: none"> 1. Check the power supply connection and voltage supply is stable or not. 2. Replace a new compressor driver board.
F03	PFC Fault		<ol style="list-style-type: none"> 1. Check the voltage between DCP-IN and DCN-IN, if lower than 300V, the unit will get this protection. 2. Check the input voltage of R/S/T on compressor driver board, if lower than 210V, the unit will get this protection. 3. If they are OK, please replace a new compressor driver board.
F05	DC Bus Over voltage		<ol style="list-style-type: none"> 1. Check the voltage between DCP-IN and DCN-IN, if lower than 300V, it will get this protection; 2. Check the input voltage of R/S/T on compressor driver board, if lower than 210V, it will get this protection; 3. If they are OK, please replace a new compressor driver board
F06	DC Bus Under voltage		<ol style="list-style-type: none"> 1. Check the voltage between DCP-IN and DCN-IN, if lower than 300V, it will get this protection; 2. Check the input voltage of R/S/T on compressor driver board, if lower than 210V, it will get this protection; 3. If they are OK, please replace a new compressor driver board
F07	AC Input Under voltage		<ol style="list-style-type: none"> 1. Measure the input voltage of R/S/T of driver board, if lower than 300V, it will get this protection. 2. If it's OK, replace a new compressor driver board.
F08	AC Input Over current		Only in single phase unit. Restart the unit. Check if there is electric leakage. If not, replace a new drive board.
F09	Input voltage sampling fault		<ol style="list-style-type: none"> 1. Make sure power supply not lower than 300V or higher than 500V; 2. If it's OK, please replace a new compressor driver board.
F10	Communication Failure between DSP and PFC		<p>Only in single phase unit.</p> <ol style="list-style-type: none"> 1. Check the inverter board connection 2. If no problem, replace a new compressor driver board.
F11	Communication Fault between DSP and Communication board		<ol style="list-style-type: none"> 1. Please check the inverter board connection. 2. If no problem, please replace a new compressor driver board
F12	Communication failure between PCB and driver board		<ol style="list-style-type: none"> 1. Check the connection between main control board and compressor driver board. All of 12V-12V, GND-GND, A-A, B-B should be closed. 2. If they are closed, turn on the power, then measure the voltage between 12V and GND on compressor driver board, if higher than 15V or lower than 7V, please replace a new one compressor driver board.

F13	IPM Overheat Stop	<ol style="list-style-type: none"> 1. Check the fans are running or not. 2. Check the installation distance and space. 3. Leave enough distance and space to make heat pump have a good transfer heating condition. 4. Clean the finned heat exchanger. 5. If they are OK, replace a new compressor driver board.
F15	Input voltage Lacking Phase	<ol style="list-style-type: none"> 1. Check the phase of power supply R/S/T to compressor driver board. 2. If it's OK, replace a new compressor driver board.
F16	Compressor weak magnetic protection alarm	<ol style="list-style-type: none"> 1. Check the refrigeration system. 2. If it's OK, replace a new compressor driver board.
F17	Temperature fault of drive board	<ol style="list-style-type: none"> 1. Check the connection of heat sink temp. sensor. 2. Check the resistance of heat sink temp. sensor. 3. If they are OK, please replace a new heat sink and heat sink temp. sensor.
F18	IPM Current Sampling Fault	<ol style="list-style-type: none"> 1. Check ambient temp. and inlet/outlet water temp. 2. Check high/low pressure and discharge temp. and suction temp. 3. Check EEV step. 4. Check the compressor frequency and current. 5. If they are OK, replace a new compressor driver board.
F20	IGBT Power Device Overheat Alarm	<ol style="list-style-type: none"> 1. Check the fans are running or not. 2. Check the installation distance and space. 3. If they are OK, please replace a new compressor driver board. 4. Leave enough distance and space to make heat pump have a good transfer heating condition. 5. Clean air to fin heat exchanger.
F22	AC input over current protection alarm	<p>Only in single phase unit. Restart the unit.</p> <ol style="list-style-type: none"> 1. Check if there is electric leakage. 2. If still have the failure, replace a new drive board.
F23	EEPROM Fault Alarm	<ol style="list-style-type: none"> 1. Check the connection; 2. Replace a new driver board;
F24	Destroyed EEPROM Activation Ban Alarm	
F25	LP 15V Under load Fault	<ol style="list-style-type: none"> 1. Check the power supply is stable or not, and restart unit. 2. If the problem still on, please replace a new drive board.
F26	IGBT Power Device Overheat Fault	<ol style="list-style-type: none"> 1. Check the fans are running or not ; 2. Check the installation distance and space; 3. Leave enough distance and space to make heat pump have a good transfer heating condition; 4. Clean the finned heat exchanger. 5. If they are OK, please replace a new driver board;
F031	DC Fan Motor 1 Failure	<ol style="list-style-type: none"> 1. Turn off the unit and check the connection. 2. Restart and check if the motor is running normal or the error happens again. 3. Replace a new fan motor.
F032	DC Fan Motor 2 Failure	

Pp1	Exhaust Pressure Sensor Fault		1. Detect the exhaust pressure sensor connection 2. If the connection is OK, please replace a new one.
Pp2	Suction Pressure Sensor Fault		1. Detect the suction pressure sensor connection 2. If the connection is OK, please replace a new one.
TP	Low Ambient Temp. Protection	Ambient temp \leq 30	1 Check the ambient temp 2. When ambient temp \geq 28 $^{\circ}$ C, the fault will disappear.
P01	Water Inlet Temp. Sensor Fault		
P02	Water Outlet Temp. Sensor Fault		
P04	Ambient Temp. Sensor Fault		
P17	Water Outlet Temp. Sensor Fault		
P032	Hot Water Tank Temp. Sensor Fault		
P42	Room Temp. Sensor Fault		1. Detect the connection. 2. Measure the resistance of sensor, if lower than 100 Ω or higher than 500k Ω , please replace a new one.
P101	EVI Inlet Temp. Sensor Fault		
P102	EVI Outlet Temp. Sensor Fault		
P153	Coil Temp. Sensor Fault		
P181	Exhaust Temp. Sensor Fault		
P182	Exhaust Over Temp.	(Exhaust temp.) \geq C05 default 110	1. Measure the resistance of sensor, if lower than 100 Ω or higher than 500k Ω , please replace a new one. 2. Check the unit find if it has refrigerant leakage.
P191	Antifreeze Temp. Sensor Fault		1. Detect the connection 2. Measure the resistance of sensor, if lower than 100 Ω or higher than 500k Ω , please replace a new one.

